Logistic Regression

Chapter 5

1

Classification

- **Learn:** $f: X \rightarrow Y$
 - X – features
 - Y – target classes

• 2

Generative vs. Discriminative Models

Generative

- Learn a model of the joint probability $p(d, c)$
- Use Bayes' Rule to calculate $p(c|d)$
- Build a model of each class; given example, return the model most likely to have generated that example
- Examples: Naive Bayes, HMM

Discriminative

Naive Bayes Review

- Features = {I hate love this book}

$$P(Y) = [1/2 \quad 1/2]$$

- Training

- I hate this book

- Love this book

$$M = \begin{bmatrix} 1 & 1 & 0 & 1 & 1 \\ 0 & 0 & 1 & 1 & 1 \end{bmatrix}$$

- What is $P(Y|X)$?

$$P(X|Y) = \begin{bmatrix} 1/4 & 1/4 & 0 & 1/4 & 1/4 \\ 0 & 0 & 1/3 & 1/3 & 1/3 \end{bmatrix}$$

- Prior $p(Y)$

$$P(Y|X) \propto [1/2 \times 1/4 \times 1/4 \quad 1/2 \times 0 \times 1/3] = [1 \quad 0]$$

- Testing

- hate book

$$M = \begin{bmatrix} 2 & 2 & 1 & 2 & 2 \\ 1 & 1 & 2 & 2 & 2 \end{bmatrix}$$

- Different conditions

- $a = 0$ (no smoothing)

- $a = 1$ (smoothing)

$$P(X|Y) = \begin{bmatrix} 2/9 & 2/9 & 1/9 & 2/9 & 2/9 \\ 1/8 & 1/8 & 2/8 & 2/8 & 2/8 \end{bmatrix}$$

$$P(Y|X) \propto [1/2 \times 2/9 \times 2/9 \quad 1/2 \times 1/8 \times 2/8] = [0.613 \quad 0.387]$$

Generative vs. Discriminative Models

Generative

- Learn a model of the joint probability $p(d, c)$
- Use Bayes' Rule to calculate $p(c|d)$
- Build a model of each class; given example, return the model most likely to have generated that example
- Examples: Naive Bayes, HMM

Discriminative

- Model $p(c|d)$ directly
- Class is a function of document vector
- Find the exact function that minimizes classification errors on the training data
- Learn boundaries between classes
- Example: Logistic regression

Linear boundary

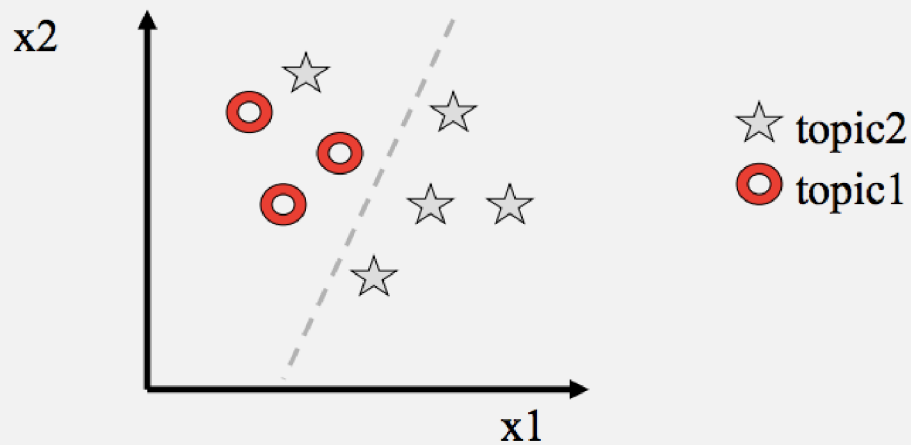

Discriminative vs. Generative Classifiers

- Discriminative classifiers are generally more effective, since they directly optimize the classification accuracy. But
 - They are sensitive to the choice of features
 - Plus: easy to incorporate linguistic information
 - Minus: until neural networks, features extracted heuristically
 - Also, overfitting can happen if data is sparse
- Generative classifiers are the “opposite”
 - They directly model text, an unnecessarily harder problem than classification

Review

- Multiclass NB and Evaluation
- NB tailored to sentiment
- Generative vs discriminative classifiers

Assumptions of Discriminative Classifiers

- Data examples (documents) are represented as vectors of features (words, phrases, ngrams, etc)
- Looking for a function that maps each vector into a class.
- This function can be found by minimizing the errors on the training data (plus other various criteria)
- Different classifiers vary on what the function looks like, and how they find the function

Linear Separators

$$f(x) = \Theta X + b$$

where

Θ is a vector of weights: w_1, \dots, w_n

X is the input vector

b is a constant

Two dimensional space:

$$w_1 x_1 + w_2 x_2 = b$$

In n-dimensional spaces:

$$\Theta X = \sum_{i=1}^n w_i x_i = w_1 x_1 + w_2 x_2 + \dots + w_n x_n$$

One can also add $w_0 = 1$, $x_0 = b$ to account for bias

Pass output of $f(x)$ to the sign function, mapping negative values to -1 and positive values to 1

How to find the weights?

- Logistic regression is one method
- Training using optimization
 - Select values for w
 - Compute $f(x)$
 - Compare $f(x)$ output to gold labels and compute loss
 - Cross-Entropy (Section 5.3)
 - Adjust w

11

What does a logistic regression model look like?

- Given document instance x and sentiment label y
- We can propose various features that we think will tell us whether y is + or -:
 - $f_1(x)$: Is the word “excellent” used in x ?
 - $f_2(x)$: How many adjectives are used in x ?
 - $f_3(x)$: How many words in x are from the positive list in our sentiment lexicon?
 - ...
- We then need some way to combine these features to help us predict y

12

A Feature Representation of the Input

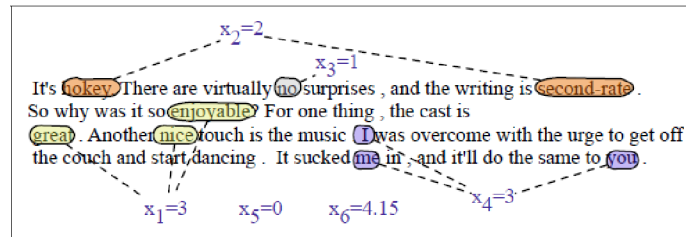

Figure 5.2 A sample mini test document showing the extracted features in the vector x .

Var	Definition	Value in Fig. 5.2
x_1	count(positive lexicon) \in doc	3
x_2	count(negative lexicon) \in doc	2
x_3	$\begin{cases} 1 & \text{if "no" } \in \text{ doc} \\ 0 & \text{otherwise} \end{cases}$	1
x_4	count(1st and 2nd pronouns \in doc)	3
x_5	$\begin{cases} 1 & \text{if "!" } \in \text{ doc} \\ 0 & \text{otherwise} \end{cases}$	0
x_6	log(word count of doc)	$\ln(64) = 4.15$

But where did the feature representation (and interactions) come from?

13

Classification Decision

$$\hat{y} = \begin{cases} 1 & \text{if } P(y=1|x) > 0.5 \\ 0 & \text{otherwise} \end{cases}$$

$$\begin{aligned} p(+|x) = P(Y=1|x) &= \sigma(w \cdot x + b) \\ &= \sigma([2.5, -5.0, -1.2, 0.5, 2.0, 0.7] \cdot [3, 2, 1, 3, 0, 4.15] + 0.1) \\ &= \sigma(.805) \\ &= 0.69 \end{aligned} \tag{5.6}$$

$$\begin{aligned} p(-|x) = P(Y=0|x) &= 1 - \sigma(w \cdot x + b) \\ &= 0.31 \end{aligned}$$

Var	Definition	Value in Fig. 5.2
x_1	count(positive lexicon) \in doc	3
x_2	count(negative lexicon) \in doc	2
x_3	$\begin{cases} 1 & \text{if "no" } \in \text{ doc} \\ 0 & \text{otherwise} \end{cases}$	1
x_4	count(1st and 2nd pronouns \in doc)	3
x_5	$\begin{cases} 1 & \text{if "!" } \in \text{ doc} \\ 0 & \text{otherwise} \end{cases}$	0
x_6	log(word count of doc)	$\ln(64) = 4.15$

But where did the weights and bias come from?

14

Motivating Logistic Regression, continued

- if $f_1(x) + f_2(x) + \dots + f_n(x) > \text{thresh}$: return + else return -
 - Problem: not all features are equally important
- if $w_0 + w_1 f_1(x) + \dots + w_n f_n(x) > 0$: return + else return -
 - Problem: not probabilistic
- Apply sigmoid function

$$f(x) = \frac{1}{1 + e^{-x}}$$

15

Using a loss function

- Training data
 - $x_1 x_2 \dots x_n$ (input)
 - $y_1 y_2 \dots y_n$ (labels)
- Algorithm that returns $f(x)$ with predictions \hat{y}
- Loss function $L(\hat{y}, y)$
- Parameters of the learned function (Θ, b) set to minimize L

16

Logistic Regression

- An example of a discriminative classifier
- Input:
 - Training example pairs of (\vec{x}, y) where \vec{x} is the feature vector and y is the label
- Goal:
 - Build a model that predicts the probability of the label
- Output:
 - Set of weights \vec{w} that maximizes likelihood of correct labels on training examples

Logistic Regression

- Similar to Naive Bayes (but discriminative!)
 - Features don't have to be independent
- Examples of features
 - Anything of use
 - Linguistic and non-linguistic
 - Count of “good”
 - Count of “not good”
 - Sentence length

Classification using LR

- Compute the feature vector x
- Multiply with weight vector w

$$z = \sum w_i x_i$$

- Compute the logistic sigmoid function

$$f(z) = \frac{1}{1 + e^{-z}}$$

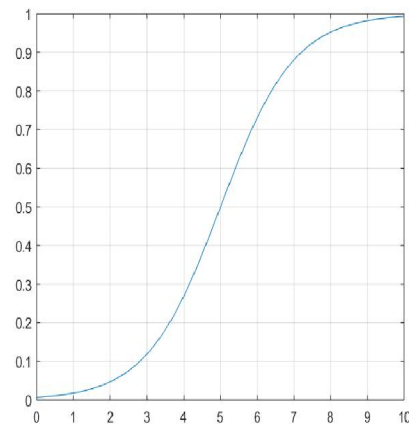

Examples

- Example 1

$$x = (2, 1, 1, 1)$$

$$w = (1, -1, -2, 3)$$

$$z = 2 - 1 - 2 + 3 = 2$$

$$f(z) = 1 / (1 + e^{-2})$$

- Example 2

$$x = (2, 1, 0, 1)$$

$$w = (0, 0, -3, 0)$$

$$z = 0$$

$$f(z) = 1 / (1 + e^0) = 1/2$$

Why Sigmoid?

First, Linear Regression

- Regression used to fit a linear model to data where the dependent variable is continuous:

$$Y = \beta_0 + \beta_1 X_1 + \beta_2 X_2 + \dots + \beta_n X_n + \varepsilon$$

- Given a set of points (X_i, Y_i) , we wish to find a linear function (or line in 2 dimensions) that “goes through” these points.
- In general, the points are not exactly aligned:
 - Find line that best fits the points

Error

- Error:
 - Observed value - Predicted value

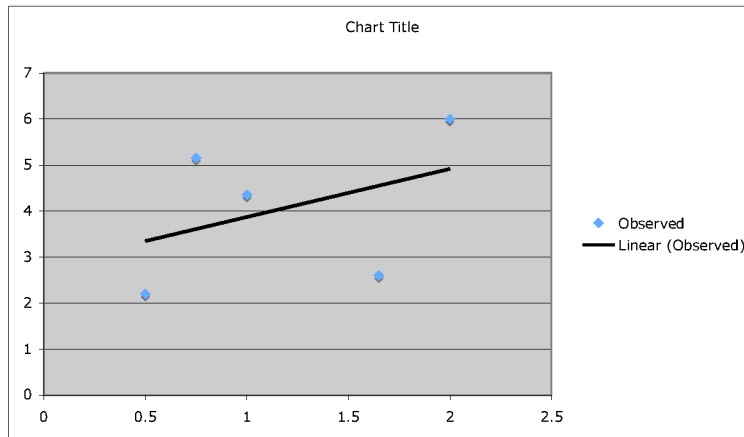

Logistic Regression

- Regression used to fit a curve to data in which the dependent variable is binary, or dichotomous
- Example application: Medicine
 - We might want to predict response to treatment, where we might code survivors as 1 and those who don't survive as 0

Example

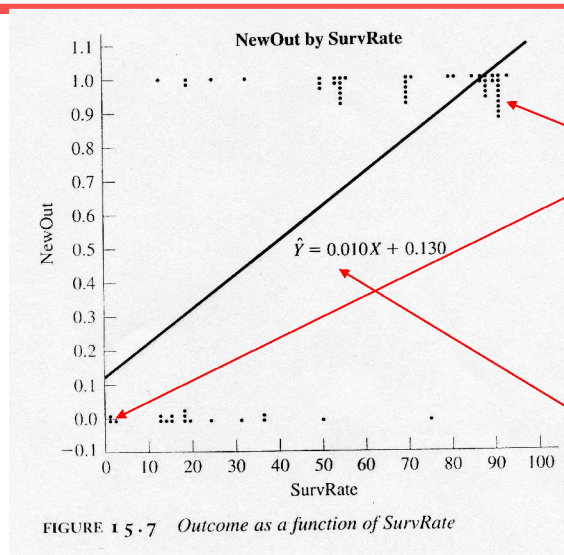

Observations:
For each value of SurvRate, the number of dots is the number of patients with that value of NewOut

Regression:
Standard linear regression

Problem: extending the regression line a few units left or right along the X axis produces predicted probabilities that fall outside of $[0,1]$

A Better Solution

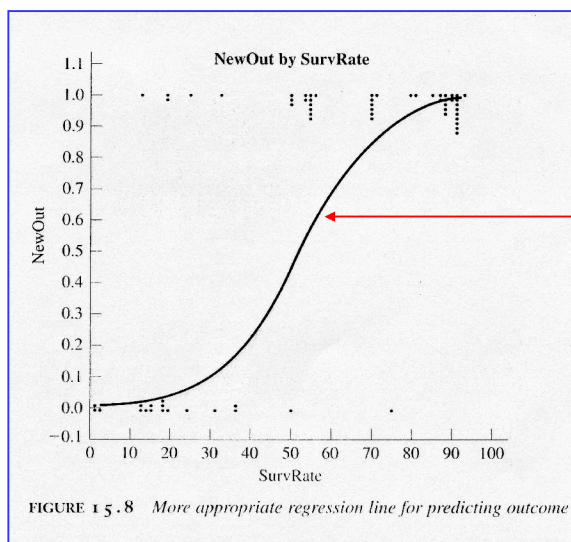

Regression Curve:
Sigmoid function!

(bounded by
asymptotes $y=0$ and
 $y=1$)

Logistic Regression

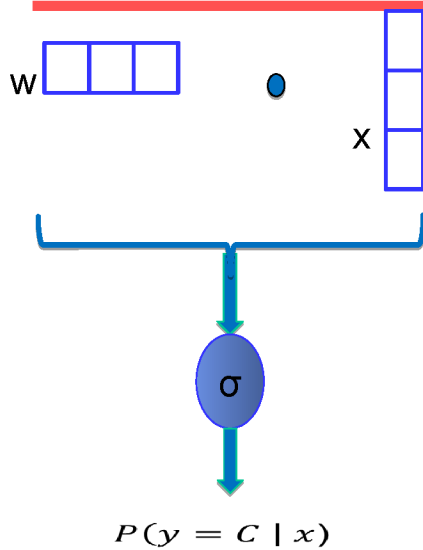

Constructing a Learning Algorithm

- The conditional data likelihood is the probability of the observed Y values in the training data, conditioned on their corresponding X values. We choose parameters \mathbf{w} that satisfy

$$\mathbf{w} = \arg \max_{\mathbf{w}} \prod_l P(y^l | \mathbf{x}^l, \mathbf{w})$$

- where $\mathbf{w} = \langle w_0, w_1, \dots, w_n \rangle$ is the vector of parameters to be estimated, y^l denotes the observed value of Y in the l th training example, and \mathbf{x}^l denotes the observed value of \mathbf{X} in the l th training example

• 27

Constructing a Learning Algorithm

- Equivalently, we can work with the log of the conditional likelihood:

$$\mathbf{w} = \arg \max_{\mathbf{w}} \sum_l \ln P(y^l | \mathbf{x}^l, \mathbf{w})$$

- This conditional data log likelihood, which we will denote $l(\mathbf{w})$ can be written as

$$l(\mathbf{w}) = \sum_l y^l \ln P(y^l = 1 | \mathbf{x}^l, \mathbf{w}) + (1 - y^l) \ln P(y^l = 0 | \mathbf{x}^l, \mathbf{w})$$

- Note here we are utilizing the fact that Y can take only values 0 or 1, so only one of the two terms in the expression will be non-zero for any given y^l

• 28

Fitting LR by Gradient Descent

- Unfortunately, there is no closed form solution to maximizing $l(\mathbf{w})$ with respect to \mathbf{w} . Therefore, one common approach is to use gradient descent
 - Beginning with initial weights of zero, we repeatedly update the weights
 - Details optional, see text, but should understand following concepts
 - Loss function
 - Gradient descent
 - Gradient, learning rate, mini-batch training
 - Regularization
 - Overfitting

• 29

Gradient Descent

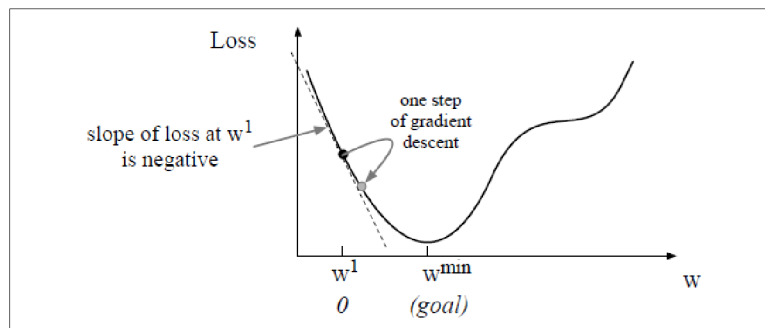

Figure 5.3 The first step in iteratively finding the minimum of this loss function, by moving w in the reverse direction from the slope of the function. Since the slope is negative, we need to move w in a positive direction, to the right. Here superscripts are used for learning steps, so w^1 means the initial value of w (which is 0), w^2 at the second step, and so on.

Learning Rate:

- the magnitude of the amount to move is the slope (more generally, the gradient) weighted by the learning rate
- if too high, overshoot minimum
- if too low, take too long to learn
- common to begin high, then decrease

30

Some Practical Issues

- Feature representation
 - want all features to have similar value ranges
 - too many features? feature selection
- Efficiency
 - Stochastic Gradient Descent / Batching
- Over-fitting
 - Regularization
- Classifying more than two categories

31

Mini-batch training

- **Stochastic** gradient descent chooses a random example at a time
- To make movements less choppy, compute gradient over batches of training instances from training set of size m
 - If batch size is m , batch training
 - If batch size is 1, stochastic gradient descent
 - Otherwise, mini batch training (for efficiency)

32

Regularization

- Weight training can yield models that don't generalize well to test data (i.e., that overfit to training data)
- To avoid overfitting, a regularization term (various options) is used to penalize large weights
 - L2 quadratic function of the weight values
 - L1 linear function of the weight values

33

Multinomial Logistic Regression

- More than two classes
- AKA softmax regression, maxent classifier
 - Instead of sigmoid, use “softmax function”
 - Instead of having just one set of weights and one set of features, different set of weights and feature vectors for each class label
 - Loss function changes too

34

Summary of Logistic Regression

- Learns the Conditional Probability Distribution $P(y|x)$
- Local Search.
 - Begins with initial weight vector.
 - Modifies it iteratively to maximize an objective function.
 - The objective function is the conditional log likelihood of the data – so the algorithm seeks the probability distribution $P(y|x)$ that is most likely given the data.

• 35

Two Phases

- Training
 - we train the system (specifically the weights w and b), e.g., using stochastic gradient descent and the cross-entropy loss
- Test
 - Given a test example x we compute $p(y | x)$ and return the higher probability label $y = 1$ or $y = 0$

36

Final Comments

- In general, NB and LR make different assumptions
 - NB: Features independent given class -> assumption on $P(X|Y)$
 - LR: Functional form of $P(Y|X)$, no assumption on $P(X|Y)$
- LR is optimized
 - no closed-form solution
- LR is interpretable

• 37

Summary

- Logistic regression is a supervised machine learning classifier (discriminative)
- Use: LR extracts real-valued features from the input, multiplies each by a weight, sums them, and passes the sum through a sigmoid function to generate a probability. A threshold is used to make a decision
- Learning: The weights (vector w and bias b) are learned from a labeled training set via a loss function that must be minimized, e.g., by using (iterative) gradient descent to find the optimal weights, and regularization to avoid overfitting

38